

AWS D1.1

Welding process	Joint designation	Base metal thickness (U = unlimited)		Root opening	Tolerances		Permitted welding positions	Gas shielding for (FCAW)	Notes
		T ₁	T ₂		As detailed	As fit up			
SMAW	B-L1a	1/4 max	-	R=T ₁	+1/16,-0	+1/4,-1/16	All	-	N
	C-L1a	1/4 max	U	R=T ₁	+1/16,-0	+1/4,-1/16	All	-	-
GMAW FCAW	B-L1a-GF	3/8 max	-	R=T ₁	+1/16,-0	+1/4,-1/16	All	Not required	A,N

Welding process	Joint designation	Base metal thickness (U = unlimited)		Root opening	Tolerances		Permitted welding positions	Gas shielding for (FCAW)	Notes
		T ₁	T ₂		As detailed	As fit up			
SMAW	B-L1b	1/4 max	-	R = T ₁ /2	+1/16,-0	+1/16,-1/8	All	-	C,N
GMAW FCAW	B-L1b-GF	3/8 max	-	R = 0 to 1/8	+1/16,-0	+1/16,-1/8	All	Not required	A,C,N
SAW	B-L1-S	1/2 max	-	R = 0	±0	+1/16,-0	Flat	-	C,D,N

Note A: Not prequalified for gas metal arc welding using short circuiting transfer.

Note C: Gouge root to sound metal before welding other side.

Note D: Welds must be centered on joint.

Note N: The orientation of the two members in the joints may vary from 135 deg to 180 deg provided that the basic joint configuration (groove angle, root face, root opening) remain the same and that the design throat thickness is maintained.

Prequalified complete joint penetration groove welded joints

AWS D1.1

Square-groove weld (1) T-joint (T) Corner joint (C)		Base metal thickness (U = unlimited)		Groove preparation			Permitted welding positions	Gas shielding for (FCAW)	Notes
Welding process	Joint designation	T ₁	T ₂	Root opening	Tolerances				
					As detailed	As fit up			
SMAW	TC-L1b	1/4 max	U	R = T ₁ /2	+1/16, -0	+1/16, -1/8	All	-	C, J
GMAW FCAW	TC-L1-GF	3/8 max	U	R = 0 to 1/8	+1/16, -0	+1/16, -1/8	All	Not req.	A, C, J
SAW	TC-L1-S	3/8 max	U	R = 0	±0	+1/16, -0	Flat	-	J

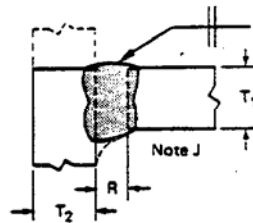

Single-V-groove weld (2) Butt joint (B)		Base metal thickness (U = unlimited)		Groove preparation		Permitted welding positions*	Gas shielding for (FCAW)	Notes
Welding process	Joint designation	T ₁	T ₂	Root opening	Groove angle			
						SMAW	8-U2a	U
SMAW	8-U2a	U	-	R = 3/8	α = 30°	F, OH	-	N
				R = 1/2	α = 20°	F, OH	-	N
				R = 3/16	α = 30°	F, V, OH	Required	A, N
GMAW FCAW	8-U2a-GF	U	-	R = 3/8	α = 30°	F	Not req.	A, N
				R = 1/4	α = 30°	V, OH	Not req.	A, N
				R = 1/4	α = 30°	F	-	N
SAW	8-L2a-S	2 max	-	R = 1/4	α = 30°	F	-	N
SAW	8-U2-S	U	-	R = 5/8	α = 20°	F	-	N

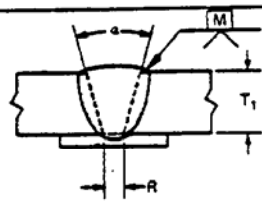

Tolerances	
As detailed	As fit up
R = +1/16, -0	+1/4, -1/16
α = +10°, -0°	+10°, -5°

Note A: Not prequalified for gas metal arc welding using short circuiting transfer.

Note C: Gouge root to sound metal before welding other side.

Note J: If fillet welds are used in buildings to reinforce groove welds in corner and T-joints, they shall be equal to 1:4 T₁ but need not exceed 3/8 in. Groove welds in corner and T-joints of bridges shall be reinforced with fillet welds equal to 1/4 T₁ but not more than 3/8 in.

Note N: The orientation of the two members in the joints may vary from 135 deg to 180 deg provided that the basic joint configuration (groove angle, root face, root opening) remain the same and that the design throat thickness is maintained.

* F = Flat, OH = Overheat.

Prequalified complete joint penetration groove welded joints

AWS D1.1

Single-V-groove weld (2) Corner joint (C)		Base metal thickness U = unlimited		Groove preparation		Tolerances		Permitted welding positions	Gas shielding for (FCAW)	Notes
						As detailed	As fit up			
						$R = +1/16, -0$	$+1/4, -1/16$			
						$\alpha = +10^\circ, -0^\circ$	$+10^\circ, -5^\circ$			

M = steel

Welding process	Joint designation	Base metal thickness		Groove preparation		Permitted welding positions	Gas shielding for (FCAW)	Notes
		U = unlimited		Root opening	Groove angle			
SMAW	C-U2a	U	U	$R = 1/4$	$\alpha = 45^\circ$	All	-	-
				$R = 3/8$	$\alpha = 30^\circ$	F, OH	-	-
				$R = 1/2$	$\alpha = 20^\circ$	F, OH	-	-
GMAW FCAW	C-U2a-GF	U	U	$R = 3/16$	$\alpha = 30^\circ$	F, V, OH	Required	A
				$R = 3/8$	$\alpha = 30^\circ$	F	Not req.	A
				$R = 1/4$	$\alpha = 30^\circ$	V, OH	Not req.	A
SAW	C-L2a-S	2 max	U	$R = 1/4$	$\alpha = 30^\circ$	F	-	-
SAW	C-U2-S	U	U	$R = 5/8$	$\alpha = 20^\circ$	F	-	-

Single-V-groove weld (2) Butt joint (B)		Base metal thickness (U = unlimited)		Groove preparation		Tolerances		Permitted welding positions	Gas shielding for (FCAW)	Notes
						As detailed	As fit up			
						$R = 0 \text{ to } 1/8$	$+1/16, -0$			
						$f = 0 \text{ to } 1/8$	$+1/16, -0$			
						$\alpha = 60^\circ$	$+10^\circ, -0^\circ$			
						$R = 0 \text{ to } 1/8$	$+1/16, -1/8$			
						$f = 0 \text{ to } 1/8$	Not limited			
						$\alpha = 60^\circ$	$+10^\circ, -5^\circ$			
SAW	B-L2b-S	Over 1/2 to 1 inclusive	-	$R = 0$	± 0	$+1/16, -0$				
				$f = 1/4 \text{ max}$	$+0, -1/4$	$\pm 1/16$				
				$\alpha = 60^\circ$	$+10^\circ, -0^\circ$	$+10^\circ, -5^\circ$				
SAW	B-L2c-S	Over 1/2 to 1	-	$R = 0, \alpha = 60^\circ$	$R = 0$	$+1/16, -0$				
		Over 1 to 1-1/2	-	$f = 1/4 \text{ max}$	$f = +0, -f$	$\pm 1/16$				
		Over 1-1/2 to 2	-	$f = 1/2 \text{ max}$	$\alpha = +10^\circ, -0^\circ$	$+10^\circ, -5^\circ$				
				$R = 0, \alpha = 60^\circ$						
				$f = 5/8 \text{ max}$						

Note A: Not prequalified for gas metal arc welding using short circuiting transfer.

Note C: Gouge root to sound metal before welding other side.

Note K: Weld root after welding at least one pass on arrow side.

Note N: The orientation of the two members in the joints may vary from 135 deg to 180 deg provided that the basic joint configuration (groove angle, root face, root opening) remain the same and that the design throat thickness is maintained.

Prequalified complete joint penetration groove welded joints

AWS D1.1

Single-V-groove weld (2) Corner joint (C)		Base metal thickness (U = unlimited)		Groove preparation			Permitted welding positions	Gas shielding for (FCAW)	Notes
Welding process	Joint designation	T ₁	T ₂	Root opening Root face Groove angle	Tolerances				
					As detailed	As fit up			
SMAW	C-U2	U	U	R = 0 to 1/8 f = 0 to 1/8 α = 60°	+1/16, -0 +1/16, -0 +10°, -0°	+1/16, -1/8 Not limited +10°, -5°	All	-	C, J
GMAW FCAW	C-U2-GF	U	U	R = 0 to 1/8 f = 0 to 1.8 α = 60°	+1/16, -0 +1/16, -0 +10°, -0°	+1/16, -1/8 Not limited +10°, -5°	All	Not required	A, C, J
SAW	C-L2b-S	1 max	U	R = 0 f = 1/4 max α = 60°	±0 +0, -1/4 +10°, -0°	+1/16, -0 ±1/16 +10°, -5°	Flat	-	J, K

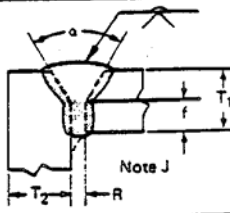

Double-V-groove weld (3) Butt joint (B)		Base metal thickness (U = unlimited)		Groove preparation			Permitted welding positions*	Gas shielding for FCAW	Notes
Welding process	Joint designation	T ₁	T ₂	Root opening	Root face	Groove angle			
							SMAW	B-U3a	U, preferably 5/8 or thicker Spacer = 1/8 x R
SAW	B-U3a-S	U Spacer = 1/4 x R	-	R = 5/8	f = 0 to 1/4	α = 20°	F	-	M, N

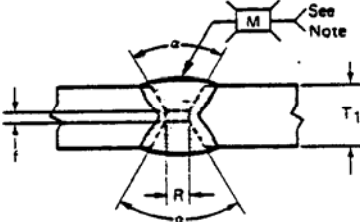

Tolerances	
As detailed	As fit up
R = ±0	+1/16, -0
f = ±0	+1/16, -0
α = +10°, -0°	+10°, -5°
Spacer = ±0	+1/16, -0

M = steel
Note: Same steel as base metal

- Note A: Not prequalified for gas metal arc welding using short circuiting transfer.
 - Note C: Gouge root to sound metal before welding other side.
 - Note J: If fillet welds are used in buildings to reinforce groove welds in corner and T-joints, they shall be equal to 1/4 T₁ but need not exceed 3/8 in. Groove welds in corner and T-joints of bridges shall be reinforced with fillet welds equal to 1/4 T₁ but not more than 3/8 in.
 - Note K: Weld root after welding at least one pass on arrow side.
 - Note M: Double-groove welds may have grooves of unequal depth, but the depth of the shallower groove shall be no less than one-fourth of the thickness of the thinner part joined.
 - Note N: The orientation of the two members in the joints may vary from 135 deg to 180 deg provided that the basic configuration (groove angle, root face, root opening) remain the same and that the design throat thickness is maintained.
- *F = Flat, OH = Overhead.

Prequalified complete joint penetration groove welded joints

AWS D1.1

Double-V-groove weld (3) Butt joint (B)		Base metal thickness (U = unlimited)		Groove preparation			Permitted welding positions	Gas shielding for (FCAW)	Notes
Welding process	Joint designation	T ₁	T ₂	Root opening Root face Groove angle	Tolerances				
					As detailed	As fit up			
SMAW	8-U3b	U, preferably 5/8 or larger	-	R = 0 to 1/8 f = 0 to 1/8 α = β = 60°	+1/16, -0 +1/16, -0 +10°, -0°	+1/16, -1/8 Not limited +10°, -5°	All	-	C, M, N
GMAW FCAW	3-U3-GF						All	Not required	A, C, M, N
SAW	8-U3b-S	1-1/8 min	-	R = 1/8 f = 0 α = β = 60° S ₁ = 2/3 T ₁ , S ₂ = 3/8 min	+1/16, -0 +1/16, -0 +10°, -0°	+1/16, -1/8 Not limited +10°, -5°	Flat	-	M, P, N, X
SAW	8-L3-S	1-1/2 max	-	R = 0 f = 1/4 max α = 60°; β = 80° S ₁ = 2/3 (T ₁ - 1/4), S ₂ = 1/3 (T ₁ - 1/4)	±0 +0, -1/4 +10°, -0°	+1/16, -0 Not limited +10°, -5°	Flat	-	M, K, N
SAW	8-U3c-S	U	-	R = 0 f = 1/4 max α = β = 60° To find S ₁ see table above; S ₂ = T ₁ - (S ₁ + 1/4)	±0 +0, -1/4 +10°, -0°	+1/16, -0 Not limited +10°, -5°	Flat	-	C, M, N

For 8-U3c-S only		
T ₁	S ₁	S ₂
Over 2	to 2-1/2	1-3/8
2-1/2	3	1-3/4
3	3-5/8	2-1/8
3-5/8	4	2-3/8
4	4-3/4	2-3/4
4-3/4	5-1/2	3-1/4
5-1/2	6-1/4	3-3/4

For T₁ > 6-1/4, or T₁ < 2
S₁ = 2/3 (T₁ - 1/4)

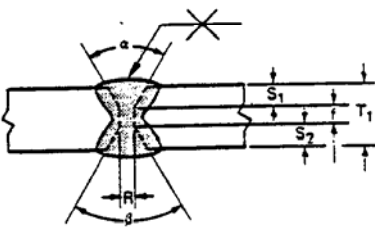

- Note A: Not prequalified for gas metal arc welding using short circuiting transfer.
- Note C: Gouge root to sound metal before welding other side.
- Note K: Weld root after welding at least one pass on arrow side.
- Note M: Double-groove welds may have grooves of unequal depth, but the depth of the shallower groove shall be no less than one-fourth of the thickness of the thinner part joined.
- Note N: The orientation of the two members in the joints may vary from 135 deg to 180 deg provided that the basic joint configuration (groove angle, root face, root opening) remain the same and that the design throat thickness is maintained.
- Note P: Weld S₂ first with gas metal arc (spray transfer), flux cored arc, or shielded metal arc with low hydrogen electrodes. The root of this weld shall be back gouged. Weld S₁ with single- or multiple-pass submerged arc welding in flat position after welding is complete on the other side.
- Note X: It is permissible for the groove opening to vary from 0-1/8 in., in which case, weld as follows: Seal weld the S₁ groove first with shielded metal arc using low hydrogen electrodes and completing the weld with submerged arc welding. The root of the seal weld shall be back-gouged. Weld the S₂ groove with shielded metal arc using low hydrogen electrode or by submerged arc welding.

Prequalified complete joint penetration groove welded joints

AWS D1.1

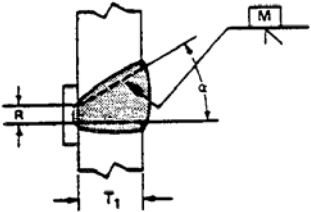
Single-bevel-groove weld (4) Butt joint (B)					<table border="1" style="margin: auto;"> <tr><th colspan="2">Tolerances</th></tr> <tr><th>As detailed</th><th>As fit up</th></tr> <tr><td>$R = +1/16, -0$</td><td>$+1/4, -1/16$</td></tr> <tr><td>$\alpha = +10^\circ, -0^\circ$</td><td>$+10^\circ, -5^\circ$</td></tr> </table>		Tolerances		As detailed	As fit up	$R = +1/16, -0$	$+1/4, -1/16$	$\alpha = +10^\circ, -0^\circ$	$+10^\circ, -5^\circ$
Tolerances														
As detailed	As fit up													
$R = +1/16, -0$	$+1/4, -1/16$													
$\alpha = +10^\circ, -0^\circ$	$+10^\circ, -5^\circ$													
		M = steel												
Welding process	Joint designation	Base metal thickness (U = unlimited)		Groove preparation		Permitted welding positions*	Gas shielding	Notes						
		T ₁	T ₂	Root opening	Groove angle									
SMAW	B-U4a	U	-	R = 1/4	$\alpha = 45^\circ$	All	-	Br, N						
				R = 3/8	$\alpha = 30^\circ$	F, OH	-	Br, N						
				R = 3/16	$\alpha = 30^\circ$	All	Required	A, Br, N						
GMAW FCAW	B-U4a-GF	U	-	R = 1/4	$\alpha = 45^\circ$	All	Not req.	A, Br, N						
				R = 3/8	$\alpha = 30^\circ$	Flat	Not req.	A, Br, N						

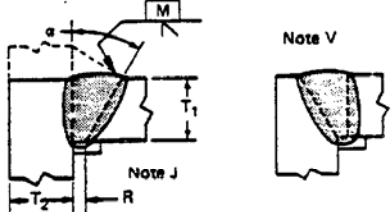
Single-bevel-groove-weld (4) T-joint (T) Corner joint (C)					<table border="1" style="margin: auto;"> <tr><th colspan="2">Tolerances</th></tr> <tr><th>As detailed</th><th>As fit up</th></tr> <tr><td>$R = -1/16, -0$</td><td>$+1/4, -1/16$</td></tr> <tr><td>$\alpha = +10^\circ, -0^\circ$</td><td>$+10^\circ, -5^\circ$</td></tr> </table>		Tolerances		As detailed	As fit up	$R = -1/16, -0$	$+1/4, -1/16$	$\alpha = +10^\circ, -0^\circ$	$+10^\circ, -5^\circ$
Tolerances														
As detailed	As fit up													
$R = -1/16, -0$	$+1/4, -1/16$													
$\alpha = +10^\circ, -0^\circ$	$+10^\circ, -5^\circ$													
		M = steel												
Welding process	Joint designation	Base metal thickness (U = unlimited)		Groove preparation		Permitted welding positions*	Gas shielding for (FCAW)	Notes						
		T ₁	T ₂	Root opening	Groove angle									
SMAW	TC-U4c	U	U	R = 1/4	$\alpha = 45^\circ$	All	-	J, V						
				R = 3/8	$\alpha = 30^\circ$	F, OH	-	J, V						
				R = 3/16	$\alpha = 30^\circ$	All	Required	A, J, V						
GMAW FCAW	TC-U4c-GF	U	U	R = 3/8	$\alpha = 30^\circ$	Flat	Not req.	A, J, V						
				R = 1/4	$\alpha = 45^\circ$	All	Not req.	A, J, V						
SAW	TC-U4a-S	U	U	R = 3/8	$\alpha = 30^\circ$	Flat	-	J, V						
				R = 1/4	$\alpha = 45^\circ$									

Note A: Not prequalified for gas metal arc welding using short circuiting transfer.

Note J: If fillet welds are used in buildings to reinforce groove welds in corner and T-joints, they shall be equal to 1/4 T₁ but need not exceed 3/8 in. Groove welds in corner and T-joints of bridges shall be reinforced with fillet welds equal to 1/4 T₁ but not more than 3/8 in.

Note N: The orientation of the two members in the joints may vary from 135 deg to 180 deg provided that the basic joint configuration (groove angle, root face, root opening) remain the same and that the design throat thickness is maintained.

Note V: For corner joints, the outside groove preparation may be in either or both members, provided the basic groove configuration is not changed and adequate edge distance is maintained to support the welding operations without excessive edge melting.

*F = Flat, OH = Overhead.

Prequalified complete joint penetration groove welded joints

AWS D1.1

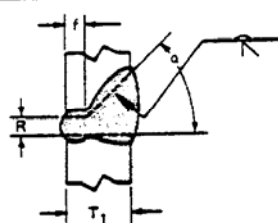
Single-bevel-groove weld (4) Butt joint (B)						Limitations Bridge application limits the use of these joints to horizontal position (see 9.12.1.5).			
Welding process	Joint designation	Base metal thickness (U = unlimited)		Groove preparation			Permitted welding positions	Gas shielding for (FCAW)	Notes
		T ₁	T ₂	Root opening Root face Groove angle	Tolerances As detailed As fit up				
SMAW	B-U4	U	-	R = 0 to 1/8 f = 0 to 1/8 α = 45°	+1/16, -0 +1/16, -0 +10°, -0°	+1/16, -1/8 not limited +10°, -5°	All	-	C, N
GMAW FCAW	B-U4-GF	U	-				All	Not required	A, C, N

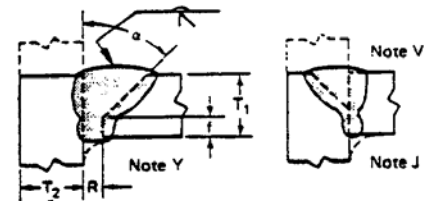
Single-bevel-groove weld (4) T-joint (T) Corner joint (C)									
Welding process	Joint designation	Base metal thickness (U = unlimited)		Groove preparation			Permitted welding positions	Gas shielding for (FCAW)	Notes
		T ₁	T ₂	Root opening Root face Groove angle	Tolerances As detailed As fit up				
SMAW	TC-U4a	U	U	R = 0 to 1/8 f = 0 to 1/8 α = 45°	+1/16, -0 +1/16, -0 +10°, -0°	+1/16, -1/8 Not limited +10°, -5°	All	-	C, J, V
GMAW FCAW	TC-U4a-GF	U	U				All	Not req.	A, C, J, V
SAW	TC-L4a-S	3/4 max	U	R = 0 f = 1/8 max α = 60°	= 0 +0, -1/8 +10°, -0°	+1/4, -0 ± 1/16 +10°, -5°	Flat	-	J, V, Y

Note A: Not prequalified for gas metal arc welding using short circuiting transfer.

Note C: Gouge root to sound metal before welding other side.

Note J: If fillet welds are used in buildings to reinforce groove welds in corner and T-joints, they shall be equal to 1/4 T₁ but need not exceed 3/8 in. Groove welds in corner and T-joints of bridges shall be reinforced with fillet welds equal to 1/4 T₁ but not more than 3/8 in.

Note N: The orientation of the two members in the joints may vary from 135 deg to 180 deg provided that the basic joint configuration (groove angle, root face, root opening) remain the same and that the design throat thickness is maintained.

Note V: For corner joints, the outside groove preparation may be in either or both members, provided the basic groove configuration is not changed and adequate edge distance is maintained to support the welding operations without excessive edge melting.

Note Y: Shielded metal arc, submerged arc, gas metal arc (spray transfer), or flux cored arc backing fillet weld required.

Prequalified complete joint penetration groove welded joints

AWS D1.1

Single-bevel-groove weld (4) T-joint (T) Corner joint (C)						<table border="1" style="width: 100%; border-collapse: collapse;"> <thead> <tr> <th colspan="2">Tolerances</th> </tr> <tr> <th>As detailed</th> <th>As fit up</th> </tr> </thead> <tbody> <tr> <td>R = -1/16, -0</td> <td>+1/4, -1/16</td> </tr> <tr> <td>alpha = -10°, -0°</td> <td>-10°, -5°</td> </tr> </tbody> </table>		Tolerances		As detailed	As fit up	R = -1/16, -0	+1/4, -1/16	alpha = -10°, -0°	-10°, -5°
Tolerances															
As detailed	As fit up														
R = -1/16, -0	+1/4, -1/16														
alpha = -10°, -0°	-10°, -5°														
		M = steel (see 8.2.4, 9.2.5, 10.2.4)													
		45° to 90°													
Welding process	Joint designation	Base metal thickness (U = unlimited)		Groove preparation		Permitted welding positions*	Gas shielding for (FCAW)	Notes							
		T ₁	T ₂	Root opening	Groove angle										
SMAW	TC-U4d	U	U	R = 1/4	alpha = 45°	All	-	J, V							
				R = 3/8	alpha = 30°	F, OH	-								
GMAW FCAW	TC-U4d-GF	U	U	R = 3/16	alpha = 30°	All	Required	A, J, V							
				R = 3/8	alpha = 30°	Flat	Not req.								
				R = 1/4	alpha = 45°	All									
SAW	TC-U4b-S	U	U	R = 3/8	alpha = 30°	Flat	-	J, V							
				R = 1/4	alpha = 45°										

Single-bevel-groove weld (4) T-joint (T) Corner joint (C)												
		45° to 90°										
Welding process	Joint designation	Base metal thickness (U = unlimited)		Root opening	Root face	Tolerances		Permitted welding positions	Gas shielding for (FCAW)	Notes		
		T ₁	T ₂			As detailed	As fit up					
						Root face	Groove angle					
SMAW	TC-U4b	U	U	R = 0 to 1/8	f = 0 to 1/8	alpha = 45°	R = 0	+1/16, -0	+1/16, -1/8	All	-	C, J, V
GMAW FCAW	TC-U4b-GF	U	U	R = 0 to 1/8	f = 0 to 1/8	alpha = 45°	R = 0	+1/16, -0	Not limited	All	Not required	A, C J, V
SAW	TC-L4b-S	3/4 max	U	R = 0	f = 1/8 max	alpha = 60°	R = 0	+0, -1/8	+1/4, -0	Flat	-	J, V, Y

Note A: Not prequalified for gas metal arc welding using short circuiting transfer.

Note C: Gouge root to sound metal before welding other side.

Note J: If fillet welds are used in buildings to reinforce groove welds in corner and T-joints, they shall be equal to 1/4 T₁ but need not exceed 3/8 in. Groove welds in corner and T-joints of bridges shall be reinforced with fillet welds equal to 1/4 T₁ but not more than 3/8 in.

Note V: For corner joints, the outside groove preparation may be in either or both members, provided the basic groove configuration is not changed and adequate edge distance is maintained to support the welding operations without excessive edge melting.

Note Y: Shielded metal arc, submerged arc, gas metal arc (spray transfer), or flux cored or backing fillet weld required.

* F = Flat, OH = Overhead.

Prequalified complete joint penetration groove welded joints

AWS D1.1

		Base metal thickness		Groove preparation			Permitted welding positions*	Gas shielding for (FCAW)	Notes
Welding process	Joint designation	(U = unlimited)		Root opening	Root face	Groove angle			
		T ₁	T ₂						
SMAW	B-U5b	U, preferably 5/8 or thicker Spacer = 1/8 X R	-	R = 1/4	f = 0 to 1/8	α = 45°	All	-	C, M, N
	TC-U5a	U, preferably 5/8 or thicker Spacer = 1/8 X R	U	R = 1/4 R = 3/8	f = 0 to 1/8	α = 45° α = 30°	All F, OH	-	C, J, M, V C, J, M, V

Double-bevel-groove weld (5)
Butt joint (B)
T-joint (T)
Corner joint (C)

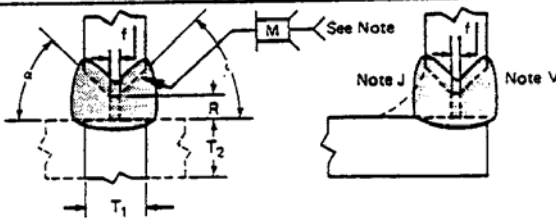

Tolerances	
As detailed	As fit up
R = ±0	+1/16, -0
f = +1/16, -0	±1/16
α = +10°, -0°	+10°, -5°
Spacer = +0	+1/16, -0

M = steel
Note: Same steel as base metal

- Note C: Gouge root of joint before welding the other side.
 - Note J: If fillet welds are used in buildings to reinforce groove welds in corner and T-joints, they shall be equal to 1/4 T₁ but need not exceed 3/8 in. Groove welds in corner and T-joints of bridges shall be reinforced with fillet welds equal to 1/4 T₁ but not more than 3/8 in.
 - Note M: Double-groove welds may have grooves of unequal depth, but the depth of the shallower groove shall be no less than one-fourth of the thickness of the thinner part joined.
 - Note N: The orientation of the two members in the joints may vary from 135 deg to 180 deg provided that the basic joint configuration (groove angle, root face, root opening) remain the same and that the design throat thickness is maintained.
 - Note V: For corner joints, the outside groove preparation may be in either or both members, provided the basic groove configuration is not changed and adequate edge distance is maintained to support the welding operations without excessive edge melting.
- * F = Flat, OH = Overhead.

Prequalified complete joint penetration groove welded joints

AWS D1.1

Double-bevel-groove weld (5) Butt joint (8)									
Welding process	Joint designation	Base metal thickness (U = unlimited)		Root opening Root face Groove angles	Tolerances		Permitted welding positions	Gas shielding for (FCAW)	Notes
		T ₁	T ₂		As detailed	As fit up			
		SMAW	B-U5a		U, preferably 5/8 or thicker	-			
GMAW FCAW	B-US-GF	U, preferably 5/8 or thicker	-	R = 0 to 1/8 f = 0 to 1/8 a = 45° j = 0°	-1/16, -0 +1/16, -0 +10°, -0° ±0°	+1/16, -1/8 Not limited +10°, -5°	All	Not req.	A, C, M

Double-bevel-groove weld (5) T-joint(T) Corner joint (C)									
Welding process	Joint designation	Base metal thickness (U = unlimited)		Root opening Root face Groove angle	Tolerances		Permitted welding positions	Gas shielding for (FCAW)	Notes
		T ₁	T ₂		As detailed	As fit up			
		SMAW	TC-USb		U, preferably 5/8 or thicker	U			
GMAW FCAW	TC-US-GF	U, preferably 5/8 or thicker	U	R = 0 to 1/8 f = 0 to 1/8 a = 45°	+1/16, -0 +1/16, -0 +10°, -0°	+1/16, -1/8 Not limited +10°, -5°	All	Not required	A, C, J, M, V
SAW	TC-US-S	U	U	R = 0 f = 3/16 max a = 60°	±0 +0, -3/16 +10°, -0°	+1/16, -0 ±1/16 +10°, -5°	Flat	-	J, M, V

Note A: Not prequalified for gas metal arc welding using short circuiting transfer.

Note C: Gouge root to sound metal before welding other side.

Note J: If fillet welds are used in buildings to reinforce groove welds in corner and T-joints, they shall be equal to 1/4 T₁ but need not exceed 3/8 in. Groove welds in corner and T-joints of bridges shall be reinforced with fillet welds equal to 1/4 T₁ but not more than 3/8 in.

Note M: Double-groove welds may have grooves of unequal depth, but the depth of the shallower groove shall be no less than one-fourth of the thickness of the thinner part joined.

Note V: For corner joints, the outside groove preparation may be in either or both members, provided the basic groove configuration is not changed and adequate edge distance is maintained to support the welding operations without excessive edge melting.

Note Z: When lower plate is beveled, make the first root pass on this side.

Prequalified complete joint penetration groove welded joints

AWS D1.1

Double-bevel-groove weld (5) T-joint (T) Corner joint (C)					Tolerances				
					As detailed	As fit up			
					$R = \pm 0$	$+1/16, -0$			
					$f = +1/16, -0$	Not limited			
					$\alpha = +10^\circ, -0^\circ$	$+10^\circ, -5^\circ$			
					Spacer = ± 0	$+1/16, -0$			
M = steel Note: Same steel as base metal									
Welding process	Joint designation	Base metal thickness (U = unlimited)		Groove preparation			Permitted welding positions*	Gas shielding for (FCAW)	Notes
		T ₁	T ₂	Root opening	Root face	Groove angle			
SMAW	TC-U5c	U, preferably 5/8 or thicker Spacer = 1/8 X R	U	R = 1/4	f = 0 to 1/8	$\alpha = 45^\circ$	All	-	C, J, V, M
				R = 3/8	f = 0 to 1/8	$\alpha = 30^\circ$	F, OH	-	C, J, V, M

Double-bevel-groove weld (5) T-joint (T) Corner joint (C)									
Welding process	Joint designation	Base metal thickness (U = unlimited)		Root opening	Tolerances		Permitted welding positions	Gas shielding for (FCAW)	Notes
		T ₁	T ₂		As detailed	As fit up			
SMAW	TC-U5d	U, preferably 5/8 or thicker	U	R = 0 to 1/8 f = 0 to 1/8 $\alpha = 45^\circ$	$+1/16, -0$	$+1/16, -1/8$	All	-	C, J, V, M
					$+1/16, -0$	Not limited			
					$+10^\circ, -0^\circ$	$+10^\circ, -5^\circ$			

Note C: Gouge root to sound metal before welding other side.

Note J: If fillet welds are used in buildings to reinforce groove welds in corner and T-joints, they shall be equal to 1/4 T₁ but need not exceed 3/8 in. Groove welds in corner and T-joints of bridges shall be reinforced with fillet welds equal to 1/4 T₁ but not more than 3/8 in.

Note M: Double-groove welds may have grooves of unequal depth, but the depth of the shallower groove shall be no less than one-fourth of the thickness of the thinner part joined.

Note V: For corner joints, the outside groove preparation may be in either or both members, provided the basic groove configuration is not changed and adequate edge distance is maintained to support the welding operations without excessive edge melting.

* F = Flat, OH = Overhead.

Prequalified complete joint penetration groove welded joints

AWS D1.1

Single-U-groove weld (6) Butt joint (B) Corner joint (C)		Base metal thickness (U = unlimited)		Groove preparation				Tolerances		Permitted welding positions*	Gas shielding for (FCAW)	Notes
Welding process	Joint designation	T ₁	T ₂	Root opening	Groove angle	Root face	Groove radius	As detailed	As fit up			
SMAW	B-U6	U	U	R = 0° to 1/8	α = 45°	f = 1/8	r = 1/4	R = -1/16, -0	+1/4, -1/16	All	-	C
				R = 0° to 1/8	α = 20°	f = 1/8	r = 1/4	α = +10°, -0°	+10°, -5°			
	C-U6	U	U	R = 0° to 1/8	α = 45°	f = 1/8	r = 1/4	f = ±1/16	Not limited			
				R = 0° to 1/8	α = 20°	f = 1/8	r = 1/4	r = +1/8, -0	±1/16			
GMAW FCAW	B-U6-GF	U	U	R = 0° to 1/8	α = 20°	f = 1/8	r = 1/4	All	Not req.	All	Not req.	A, C, J
	C-U6-GF	U	U	R = 0° to 1/8	α = 20°	f = 1/8	r = 1/4					

Double-U-groove weld (7) Butt joint (B)		Base metal thickness (U = unlimited)		Groove preparation				Tolerances For 8-U7 and 8-U7-GF		Tolerances For 8-U7-S		Permitted welding positions*	Gas shielding for (FCAW)	Notes
Welding process	Joint designation	T ₁	T ₂	Root opening	Groove angle	Root face	Groove radius	As detailed	As fit up	As detailed	As fit up			
SMAW	B-U7	U, preferably 5/8 or thicker	-	R = 0 to 1/8	α = 45°	f = 1/8	r = 1/4	R = +1/16, -0	+1/16, -1/8	All	-	C, M		
				R = 0 to 1/8	α = 20°	f = 1/8	r = 1/4	α = +10°, -0	+10°, -5°					
GMAW FCAW	B-U7-GF	U, preferably 5/8 or thicker	-	R = 0 to 1/8	α = 20°	f = 1/8	r = 1/4	f = +1/16, -0	Not limited	All	Not required	A, C, M		
				R = 0 to 1/8	α = 20°	f = 1/8	r = 1/4	r = +1/8, -0	±1/16					
SAW	8-U7-S	U	-	R = 0	α = 20°	f = 1/4 max	r = 1/4			F	-	M		

Note A: Not prequalified for gas metal arc welding using short circuiting transfer.

Note C: Gauge root to sound metal before welding other side.

Note J: If fillet welds are used in buildings to reinforce groove welds in corner and T-joints, they shall be equal to 1/4 T₁, but need not exceed 3/8 in. The reinforcement of groove welds in corner joints, when required, and T-joints in bridges shall be made with fillet welds equal to 1/4 T₁. These fillet welds need not exceed 3/8 in.

Note M: Double-groove welds may have grooves of unequal depth, but the depth of the shallower groove shall be no less than one-fourth of the thickness of the thinner part joined.

* F = Flat, OH = Overhead.

Prequalified complete joint penetration groove welded joints

AWS D1.1

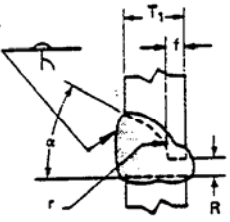
Single-J-groove weld (B) Butt joint (B)						Tolerances				
						As detailed		As fit up		
						R = +1/16, -0		+1/16, -1/8		
						α = +10°, -0°		+10°, -5°		
						f = +1/16, -0		Not limited		
						r = +1/8, -0		±1/16		
Welding process	Joint designation	Base metal thickness (U = unlimited)		Groove preparation				Permitted welding positions	Gas shielding for (FCAW)	Notes
		T ₁	T ₂	Root opening	Groove angle	Root face	Groove radius			
SMAW	B-U8	U	-	R = 0 to 1/8	α = 45°	f = 1/8	r = 3/8	All	-	Br, C
GMAW FCAW	B-UB-GF	U	-	R = 0 to 1/8	α = 30°	f = 1/8	r = 3/8	All	Not required	A, Br, C

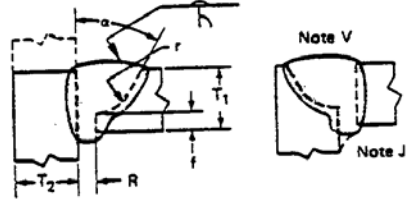
Single-J-groove weld (B) T-joint (T) Corner joint (C)						Tolerances				
						As detailed		As fit up		
						R = +1/16, -0		+1/16, -1/8		
						α = +10°, -0°		+10°, -5°		
						f = +1/16, -0		Not limited		
						r = +1/8, -0		±1/16		
Welding process	Joint designation	Base metal thickness (U = unlimited)		Groove preparation				Permitted welding positions	Gas shielding for (FCAW)	Notes
		T ₁	T ₂	Root opening	Groove angle	Root face	Groove radius			
SMAW	TC-UBa	U	U	R = 0 to 1/8	α = 45°	f = 1/8	r = 3/8	All	-	C, J, V
				R = 0 to 1/8	α = 30°	f = 1/8	r = 3/8	F, OH	-	C, J, V
GMAW FCAW	TC-UBa-GF	U	U	R = 0 to 1/8	α = 30°	f = 1/8	r = 3/8	All	Not required	A, C, J, V

Note A: Not prequalified for gas metal arc welding using short circuiting transfer.

Note Br: Bridge application limits the use of these joints to the horizontal position

Note C: Gauge root to sound metal before welding other side.

Note J: If fillet welds are used in buildings to reinforce groove welds in corner and T-joints, they shall be equal to 1/4 T₁ but need not exceed 3/8 in. Groove welds in corner and T-joints of bridges shall be reinforced with fillet welds equal to 1/4 T₁ but not more than 3/8 in.

Note V: For corner joints, the outside groove preparation may be in either or both members, provided the basic groove configuration is not changed and adequate edge distance is maintained to support the welding operations without excessive edge melting.

* F = Flat, OH = Overhead.

Prequalified complete joint penetration groove welded joints

AWS D1.1

Single-J-groove weld (8) T-joint (T) Corner joint (C)		Base metal thickness (U = unlimited)		Groove preparation				Permitted welding positions*	Gas shielding for (FCAW)	Notes
				Root opening	Groove angle	Root face	Groove radius			
SMAW	TC-U8b	U	U	R = 0 to 1/8	$\alpha = 45^\circ$	f = 1/8	r = 3/8	All	-	C, J, V
				R = 0 to 1/8	$\alpha = 30^\circ$	f = 1/8	r = 3/8	F, OH	-	C, J, V
GMAW FCAW	TC-U8b-GF	U	U	R = 0 to 1/8	$\alpha = 30^\circ$	f = 1/8	r = 3/8	All	Not required	A, C, J, V

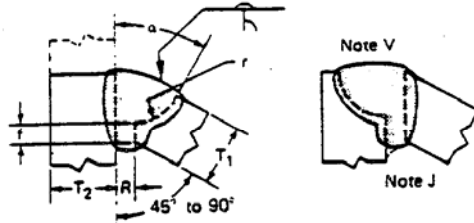

Tolerances	
As detailed	As fit up
R = +1/16, -0	+1/16, -1/8
$\alpha = +10^\circ, -0^\circ$	+10°, -5°
f = +1/16, -0	Not limited
r = +1/8, -0	±1/16

Double-J-groove weld (9) Butt joint (B)		Base metal thickness (U = unlimited)		Groove preparation				Permitted welding positions	Gas shielding for (FCAW)	Notes
				Root opening	Groove angle	Root face	Groove radius			
SMAW	B-U9	U, preferably 5/8 or thicker	-	R = 0 to 1/8	$\alpha = 45^\circ$	f = 1/8	r = 3/8	All	-	Br, C, M
GMAW FCAW	B-U9-GF	U, preferably 5/8 or thicker	-	R = 0 to 1/8	$\alpha = 30^\circ$	f = 1/8	r = 3/8	All	Not required	A, Br, C, M

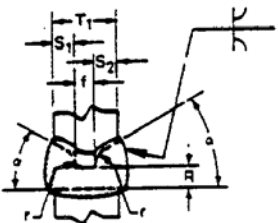

Tolerances	
As detailed	As fit up
R = +1/16, -0	+1/16, -1/8
$\alpha = +10^\circ, -0^\circ$	+10°, -5°
f = +1/16, -0	Not limited
r = +1/8, -0	±1/16

Note A: Not prequalified for gas metal arc welding using short circuiting transfer.

Note Br: Bridge application limits the use of these joints to the horizontal position

Note C: Gouge root to sound metal before welding other side.

Note J: If fillet welds are used in buildings to reinforce groove welds in corner and T-joints, they shall be equal to 1/4 T₁ but need not exceed 3/8 in. Groove welds in corner and T-joints of bridges shall be reinforced with fillet welds equal to 1/4 T₁ but not more than 3/8 in.

Note M: Double-groove welds may have grooves of unequal depth, but the depth of the shallower groove shall be no less than one-fourth of the thickness of the thinner part joined.

Note V: For corner joints, the outside groove preparation may be in either or both members, provide the basic groove configuration is not changed and adequate edge distance is maintained to support the welding operations without excessive edge melting.

* F = Flat, OH = Overhead.

Prequalified complete joint penetration groove welded joints

AWS D1.1

				Tolerances							
				As detailed	As fit up						
Double-J-groove weld (9) T-joint (T) Corner joint (C)								R = +1/16, -0	+1/16, -1/8		
				alpha = +10°, -0°				+10°, -5°			
				f = +1/16, -0				Not limited			
				r = +1/8, -0				±1/16			
Welding process	Joint designation	Base metal thickness (U = unlimited)		Groove preparation				Permitted welding positions	Gas shielding for (FCAW)	Notes	
		T ₁	T ₂	Root opening	Groove angle	Root face	Groove radius				
SMAW	TC-U9a	U, preferably 5/8 or thicker	U	R = 0 to 1/8	alpha = 45°	f = 1/8	r = 3/8	All	-	C, J, M, V	
				R = 0 to 1/8	alpha = 30°	f = 1/8	r = 3/8	F, OH	-	C, J, M, V	
GMAW FCAW	TC-U9a-GF	U, preferably 5/8 or thicker	U	R = 0 to 1/8	alpha = 30°	f = 1/8	r = 3/8	All	Not required	A, C, J, M, V	

				Tolerances							
				As detailed	As fit up						
Double-J-groove weld (9) T-joint (T) Corner joint (C)								R = +1/16, -0	+1/16, -1/8		
				alpha = +10°, -0°				+10°, -5°			
				f = +1/16, -0				Not limited			
				r = +1/8, -0				±1/16			
Welding process	Joint designation	Base metal thickness (U = unlimited)		Groove preparation				Permitted welding positions*	Gas shielding for (FCAW)	Notes	
		T ₁	T ₂	Root opening	Groove angle	Root face	Groove radius				
SMAW	TC-U9b	U, preferably 5/8 or thicker	U	R = 0 to 1/8	alpha = 45°	f = 1/8	r = 3/8	All	-	C, J, M, V	
				R = 0 to 1/8	alpha = 30°	f = 1/8	r = 3/8	F, OH	-	C, J, M, V	
GMAW FCAW	TC-U9b-GF	U, preferably 5/8 or thicker	U	R = 0 to 1/8	alpha = 30°	f = 1/8	r = 3/8	All	Not required	A, C, J, M, V	

Note A: Not prequalified for gas metal arc welding using short circuiting transfer.

Note C: Gouge root to sound metal before welding other side.

Note J: If fillet welds are used in buildings to reinforce groove welds in corner and T-joints, they shall be equal to 1/4 T₁ but need not exceed 3/8 in. Groove welds in corner and T-joints of bridges shall be reinforced with fillet welds equal to 1/4 T₁ but not more than 3/8 in.

Note M: Double-groove welds may have grooves of unequal depth, but the depth of the shallower groove shall be no less than one-fourth of the thickness of the thinner part joined.

Note V: For corner joints, the outside groove preparation may be in either or both members, provided the basic groove configuration is not changed and adequate edge distance is maintained to support the welding operations without excessive edge melting.

* F = Flat, OH = Overhead.

Prequalified complete joint penetration groove welded joints

AWS D1.1

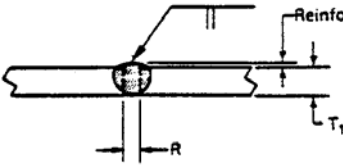
Square-groove weld (1) Butt joint (B)									
Welding process	Joint designation	Base metal thickness (U = unlimited)		Groove preparation			Permitted welding positions	Effective throat (E)	Notes
		T ₁	T ₂	Root opening	Tolerances				
					As detailed	As fit up			
SMAW	B-P1a	1/8 max	-	R = 0 to 1/16	+1/16, -0	± 1/16	All	T ₁ - 1/16	B
	B-P1c	1/4 max	-	R = $\frac{T_1}{2}$ min	+1/16, -0	± 1/16	All	$\frac{T_1}{2}$	B

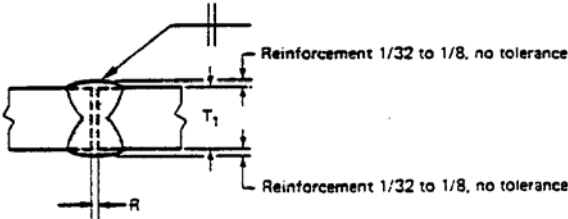
Square-groove weld (1) Butt joint (B)									
Welding process	Joint designation	Base metal thickness (U = unlimited)		Groove preparation			Permitted welding positions	Effective throat (E)	Notes
		T ₁	T ₂	Root opening	Tolerances				
					As detailed	As fit up			
SMAW	B-P1b	1/4 max	-	$\frac{T_1}{2}$	= 0	+3/16 see also 3.3.2	All	$\frac{3T_1}{4}$	C2

Note B: Joints welded from one side.

Note C2: Root need not be gauged before welding second side.

Prequalified partial joint penetration groove welded joints

AWS D1.1

Welding process	Joint designation	Base metal thickness (U = unlimited)		Groove preparation			Permitted welding positions	Effective throat (E)	Notes
		T ₁	T ₂	Root opening Root face Groove radius Groove angle	Tolerances				
					As detailed	As fit up			
SMAW	BTC-P9	1/2 min (for bridges 5/8 min)	U	R = 0 to 1/8 f = 1/8 min r = 3/8 α = 45°	+1/16, -0 -0 +1/4, -0 +10°, -0°	±1/16 ±1/16 ±1/16 +10°, -5°	All	S	E, L, J, V
GMAW FCAW	BTC-P9-GF	1/2 min (for bridges 5/8 min)	U	R = 0 f = 1/8 min r = 3/8 α = 30°	+1/16, -0 -0 +1/4, -0 +10°, -0°	±1/16 ±1/16 ±1/16 +10°, -5°	All	S	A, E, L, V, J
SAW	C-P9-S	3/4 min (for bridges 7/8 min)	U	α = 20°	+10°, -0°	+10°, -5°	Flat	S	E, V, J
	T-P9-S	3/4 min	U	R = 0 f = 1/4 min r = 1/2 α = 45°	±0 -0 +1/4, -0 +10°, -0°	+3/16, -0 ±1/16 ±1/16 +10°, -5°	Flat	S	E, L

Note A: Not prequalified for gas metal arc welding using short circuiting transfer.

Note E: Minimum effective throat (E) as shown.

Note J: If fillet welds are used in buildings to reinforce groove welds in corner and T-joints, they shall be equal to 1/4 T₁ but need not exceed 3/8 in. Groove welds in corner and T-joints of bridges shall be reinforced with fillet welds equal to 1/4 T₁ but not more than 3/8 in.

Note L: Butt and T-joints are not prequalified for bridges.

Note Mp: Double-groove welds may have grooves of unequal depth, provided they conform to the limitations of Note E. Also, the effective throat (E), less any reduction, applies individually to each groove.

Note V: For corner joints, the outside groove preparation may be in either or both members, provided the basic groove configuration is not changed and adequate edge distance is maintained to support the welding operations without excessive edge melting.

Prequalified partial joint penetration groove welded joints

AWS D1.1

Welding process	Joint designation	Base metal thickness (U = unlimited)		Groove preparation			Permitted welding positions	Effective throat (E)	Notes
		T ₁	T ₂	Root opening Root face Groove radius Groove angle	Tolerances				
					As detailed	As fit up			
SMAW	BTC-P8	1/4 min (for bridges 5/16 min)	U	$\alpha = 45^\circ$	+10°, -0°	+10°, -5°	All	S	E, L, V
				R = 0 to 1/8 f = 1/8 min r = 3/8	+1/16, -0 -0	$\pm 1/16$ $\pm 1/16$			
GMAW FCAW	BTC-P8-GF	1/4 min (for bridges 5/16 min)	U	$\alpha = 30^\circ$	+10°, -0°	+10°, -5°	All	S	A, E, L, V
				$\alpha = 20^\circ$	+10°, -0°	+10°, -5°			
SAW	C-P8-S	7/16 min (for bridges 1/2 min)	U	R = 0 f = 1/4 min r = 1/2	± 0 -0 +1/4, -0	+3/16, -0 \pm $\pm 1/16$ $\pm 1/16$	Flat	S	E, V
				$\alpha = 45^\circ$	+10°, -0°	+10°, -5°			
SAW	T-P8-S	7/16 min	U				Flat	S	E, L

Note A: Not prequalified for gas metal arc welding using short circuiting transfer.

Note E: Minimum effective throat (E)

Note L: Butt and T-joints are not prequalified for bridges.

Note V: For corner joints, the outside groove preparation may be in either or both members, provided the basic groove configuration is not changed and adequate edge distance is maintained to support the welding operations without excessive edge melting.

Prequalified partial joint penetration groove welded joints

AWS D1.1

Welding process	Joint designation	Base metal thickness (U = unlimited)		Groove preparation			Permitted welding positions	Effective throat (E)	Notes
		T ₁	T ₂	Root opening Root face Groove radius Groove angle	Tolerances				
					As detailed	As fit up			
SMAW	BC-P6	1/4 min (for bridges 5/16 min)	U	R = 0 to 1/8 f = 1/8 min r = 1/4 α = 45°	+1/16, -0 -0 +1/4, -0 +10°, -0°	±1/16 ±1/16 ±1/16 +10°, -5°	All	S	E, L
GMAW FCAW	BC-P6-GF	1/4 min (for bridges 5/16 min)	U	R = 0 f = 1/8 min r = 1/4 α = 20°	+1/16, -0 -0 +1/4, -0 +10°, -0°	±1/16 ±1/16 ±1/16 +10°, -5°	All	S	A, E, L
SAW	BC-P6-S	7/16 min (for bridges 1/2 min)	U	R = 0 f = 1/4 min r = 1/4 α = 20°	=0 -0 +1/4, -0 +10°, -0°	+3/16, -0± ±1/16 ±1/16 +10°, -5°	Flat	S	E, L

Note A: Not prequalified for gas metal arc welding using short circuiting transfer.

Note E: Minimum effective throat (E)

Note L: Butt and T-joints are not prequalified for bridges.

Prequalified partial joint penetration groove welded joints

AWS D1.1

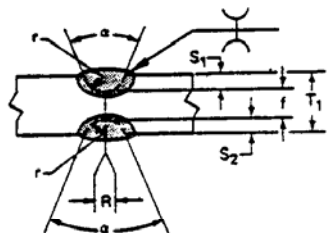
Double-V-groove weld (7) Butt joint (B)											
Welding process	Joint designation	Base metal thickness (U = unlimited)		Groove preparation			Permitted welding positions	Effective throat (E)	Notes		
		T ₁	T ₂	Root opening	Root face	Groove radius				Tolerances	
				Groove angle	As detailed	As fit up					
SMAW	B-P7	1/2 min (for bridges 5/8 min)	-	R = 0 to 1/8 f = 1/8 min r = 1/4 α = 45°	+1/16, -0 -0 +1/4, -0 +10°, -0°	±1/16 ±1/16 ±1/16 +10°, -5°	All	S	E; L, Mp		
GMAW FCAW	B-P7-GF	1/2 min (for bridges 5/8 min)	-	R = 0 f = 1/8 min r = 1/4 α = 20°	+1/16, -0 -0 +1/4, -0 +10°, -0°	±1/16 ±1/16 ±1/16 +10°, -5°	All	S	A, E, L, Mp		
SAW	B-P7-S	3/4 min (for bridges 7/8 min)	-	R = 0 f = 1/4 min r = 1/4 α = 20°	±0 -0 +1/4, -0 +10°, -0°	+3/16, -0± ±1/16 ±1/16 +10°, -5°	Flat	S	E, L, Mp		

Note A: Not prequalified for gas metal arc welding using short circuiting transfer.

Note E: Minimum effective throat (E)

Note L: Butt and T-joints are not prequalified for bridges.

Note Mp: Double-groove welds may have grooves of unequal depth, provided they conform to the limitations of Note E. Also, the effective throat (E), less any reduction, applies individually to each groove.

Prequalified partial joint penetration groove welded joints

AWS D1.1

Welding process	Joint designation	Base metal thickness (U = unlimited)		Root opening Root face Groove angle	Groove preparation Tolerances		Permitted welding positions*	Effective throat (E)	Notes
		T ₁	T ₂		As detailed	As fit up			
SMAW	BTC-P5	1 min (for bridges 1-1/8 min)	U	R = 0 f = 1/8 min α = 45°	+1/16, -0 -0 +10°, -0°	±1/16 ±1/16 +10°, -5°	All	S - 1/8	E, L, Mp, V
GMAW FCAW	BTC-P5-GF	1/2 min (for bridges 5/8 min) 1 min	U	R = 0 f = 1/8 min α = 45°	+1/16, -0 -0 +10°, -0°	±1/16 ±1/16 +10°, -5°	F, H V, OH	S - 1/8	A, E, L, Mp, V
SAW	TC-P5-S	3/4 min (for bridges 7/8 min)	U	R = 0 f = 1/4 min α = 60°	±0 -0 +10°, -0°	+3/16, -0± ±1/16 +10°, -5°	Flat	S	E, L, Mp, V

Note A: Not prequalified for gas metal arc welding using short circuiting transfer.

Note E: Minimum effective throat (E)

Note L: Butt and T-joints are not prequalified for bridges.

Note Mp: Double-groove welds may have grooves of unequal depth, provided they conform to the limitations of Note E. Also, the effective throat (E), less any reduction, applies individually to each groove.

Note V: For corner joints, the outside groove preparation may be in either or both members, provided the basic groove configuration is not changed and adequate edge distance is maintained to support the welding operations without excessive edge melting.

* F = Flat, H = Horizontal, V = Vertical, OH = Overhead.

Prequalified partial joint penetration groove welded joints

AWS D1.1

Welding process	Joint designation	Base metal thickness (U = unlimited)		Groove preparation			Permitted welding positions*	Effective throat (E)	Notes
		T ₁	T ₂	Root opening Root face Groove angle	Tolerances				
					As detailed	As fit up			
SMAW	BTC-P4	7/16 min (for bridges 1/2 min)	U	R = 0 f = 1/8 min α = 45°	+1/16, -0 -0 +10°, -0°	±1/16 ±1/16 +10°, -5°	All	S - 1/8	E, L, V
GMAW FCAW	BTC-P4-GF	1/4 min (for bridges 5/16 min)	U	R = 0 f = 1/8 min α = 45°	+1/16, -0 -0 +10°, -0°	±1/16 ±1/16 +10°, -5°	F, H	S - 1/8	A, E, L, V
	7/16 min	V, OH							
SAW	TC-P4-S	7/16 min (for bridges 1/2 min)	U	R = 0 f = 1/4 min α = 60°	±0 -0 +10°, -0°	+3/16, -0± ±1/16 +10°, -5°	Flat	S	E, L, V

Note A: Not prequalified for gas metal arc welding using short circuiting transfer.

Note E: Minimum effective throat (E)

Note L: Butt and T-joints are not prequalified for bridges.

Note V: For corner joints, the outside groove preparation may be in either or both members, provided the basic groove configuration is not changed and adequate edge distance is maintained to support the welding operations without excessive edge melting.

* F = Flat, H = Horizontal, V = Vertical, OH = Overhead.

Prequalified partial joint penetration groove welded joints

AWS D1.1

Double-V-groove weld (3)
Butt joint (B)

Welding process	Joint designation	Base metal thickness (U = unlimited)		Groove preparation			Permitted welding positions	Effective throat (E)	Notes
		T ₁	T ₂	Root opening Root face Groove angle	Tolerances				
					As detailed	As fit up			
SMAW	B-P3	1/2 min	-	R = 0 f = 1/8 min α = 60°	+1/16, -0 -0 +10°, -0°	±1/16 ±1/16 +10°, -5°	All	S	E, L Mp
GMAW FCAW	B-P3-GF	1/2 min	-	R = 0 f = 1/8 min α = 60°	+1/16, -0 -0 +10°, -0°	±1/16 ±1/16 +10°, -5°	All	S	A, E, L, Mp
SAW	B-P3-S	3/4 min	-	R = 0 f = 1/4 min α = 60°	±0 -0 +10°, -0°	+3/16, -0+ ±1/16 +10°, -5°	Flat	S	E, L Mp

Single-bevel-groove weld (4)
Butt joint (B)
T-joint (T)
Corner joint (C)

S = T₁

Note W

Welding process	Joint designation	Base metal thickness (U = unlimited)		Groove preparation			Permitted welding positions	Effective throat (E)	Notes
		T ₁	T ₂	Root opening Root face Groove angle	Tolerances				
					As detailed	As fit up			
SMAW	BTC-P4a	1/2 max	-	R = 3/32 min f = 0 to 1/8 α = 45°	R = min ±1/16 +10°, -0°	±1/16 ±1/16 +10°, -5°	All	S - 1/8	B, L, W

Note A: Not prequalified for gas metal arc welding using short circuiting transfer.

Note B: Joint is welded from one side only.

Note E: Minimum effective throat (E)

Note L: Butt and T-joints are not prequalified for bridges.

Note Mp: Double-groove welds may have grooves of unequal depth, provided they conform to the limitations of Note E. Also, the effective throat (E), less any reduction, applies individually to each groove.

Note W: Unbeveled face is the lower edge for horizontal position.

Prequalified partial joint penetration groove welded joints

AWS D1.1

Single-V-groove weld (2) Butt joint (B) Corner joint (C)								BC-P2 BC-P2-GF BC-P2-S	
Welding process	Joint designation	Base metal thickness (U = unlimited)		Groove preparation Root opening Root face Groove angle	Tolerances		Permitted welding positions	Effective throat (E)	Notes
		T ₁	T ₂		As detailed	As fit up			
SMAW	BC-P2	1/4 min (for bridges 5/16 min)	U	R = 0 f = 1/8 min α = 60°	±0 ±1/16 +10°, -0°	+1/16, -0 ±1/16 +10°, -5°	All	S	E, L
GMAW FCAW	BC-P2-GF	1/4 min (for bridges 5/16 min)	U	R = 0 f = 1/8 min α = 60°	±0 ±1/16 +10°, -0°	+1/16, -0 ±1/16 +10°, -5°	All	S	A, E, L
SAW	BC-P2-S	7/16 min	U	R = 0 f = 1/4 min α = 60°	±0 ±1/16 +10°, -0°	+1/16, -0 ±1/16 +10°, -5°	Flat	S	E, L

Note A: Not prequalified for gas metal arc welding using short circuiting transfer.

Note B: Joint is welded from one side only.

Note E: Minimum effective throat (E)

Note L: Butt and T-joints are not prequalified for bridges.

Prequalified partial joint penetration groove welded joints

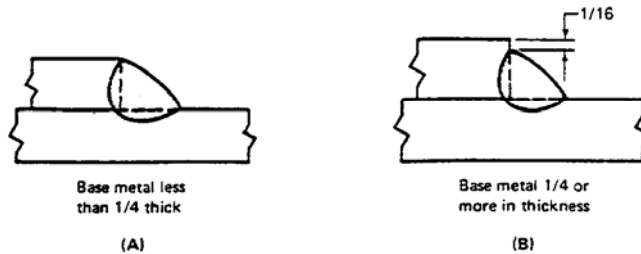

Maximum size of fillet weld along edges

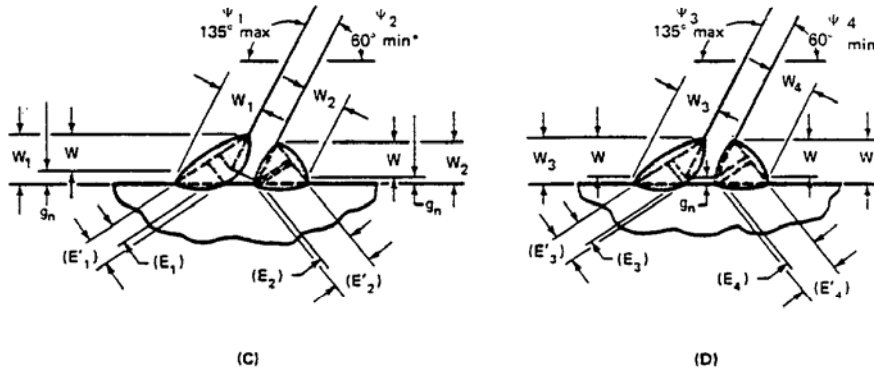

Skewed T-joints

Note: $(E)_{in}$, $(E')_{in}$ = effective throats dependent on magnitude of gap (g_n).

*Angles smaller than 60 degrees are permitted; however, in such cases, the weld is considered to be a partial joint penetration groove weld.

Details for prequalified fillet welds

Minimum fillet weld size for prequalified joints

Base metal thickness of thicker part jointed (T)		Minimum size of fillet weld*	
in.	mm	in.	mm
$T \leq 1/4$	$T \leq 6.4$	1/8**	3
$1/4 < T \leq 1/2$	$6.4 < T \leq 12.7$	3/16	5
$1/2 < T \leq 3/4$	$12.7 < T \leq 19.0$	1/4	6
$3/4 < T$	$19.0 < T$	5/16	8

*Except that the weld size need not exceed the thickness of the thinner part joined. For this exception, particular care should be taken to provide sufficient preheat to ensure weld soundness.

BACKING OF THICKNESS SUFFICIENT TO PREVENT MELT THROUGH

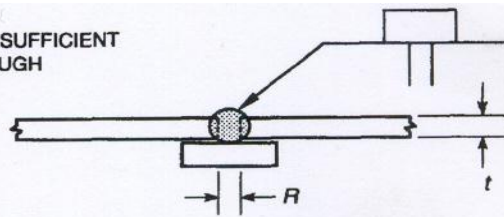

WELDING PROCESSES	THICKNESS, <i>t</i> (NOTE 1)	<i>R</i> = ROOT OPENING	POSITIONS
ALL	18 Ga. (MIN), 12 Ga. (MAX)	0 (MIN), <i>t</i> (MAX)	ALL
	11 Ga. (MIN), 7 Ga. (MAX)	3/4 <i>t</i> (MIN), <i>t</i> (MAX)	

Note:

1. For equivalent thicknesses for supporting structural members in sheet metal gage terms, use 3/16 in. for 7 Ga., 1/8 in. for 11 Ga.

Square Groove Weld in Butt Joint with Steel Backing

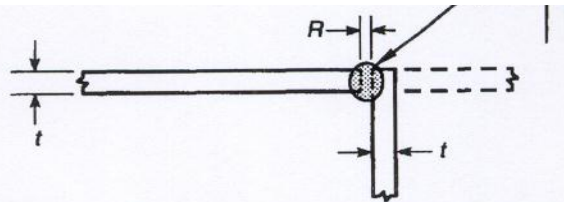

WELDING PROCESSES	THICKNESS, <i>t</i> (NOTE 1)	<i>R</i> = ROOT OPENING	POSITIONS
ALL	18 Ga. (MIN), 12 Ga. (MAX)	0 (MIN)	ALL
	11 Ga. (MIN), 7 Ga. (MAX)	<i>t</i> (MAX)	

Note:

1. For equivalent thicknesses for supporting structural members in sheet metal gage terms, use 3/16 in. for 7 Ga., 1/8 in. for 11 Ga.

Square Groove Weld in Butt or Corner Joint without Backing

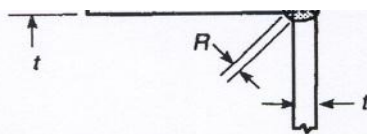

WELDING PROCESSES	THICKNESS, <i>t</i> (NOTE 1)	<i>R</i> = ROOT OPENING	POSITIONS
ALL	18 Ga. (MIN)	0 (MIN)	ALL
	11 Ga. (MIN)	<i>t</i> /4 (MAX)	

Note:

1. For equivalent thicknesses for supporting structural members in sheet metal gage terms, use 3/16 in. for 7 Ga., 1/8 in. for 11 Ga.

Fillet Weld in Corner Joint

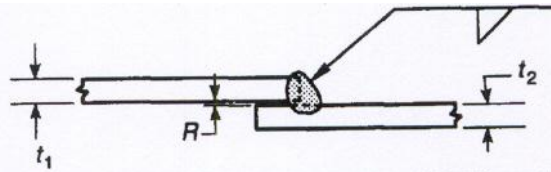

WELDING PROCESSES	THICKNESS, t_1 or t_2 (NOTE 2)	R = ROOT OPENING	POSITIONS
ALL	18 Ga. (MIN)	0 (MIN)	ALL
	7 Ga. (MAX)	$t_1/2$ (MAX) (SEE NOTE 1)	

Notes:

- t_1 = thinnest member when two different thicknesses are involved.
- For equivalent thicknesses for supporting structural members in sheet metal gage terms, use 3/16 in. for 7 Ga., 1/8 in. for 11 Ga.

Fillet Weld in Lap Joint

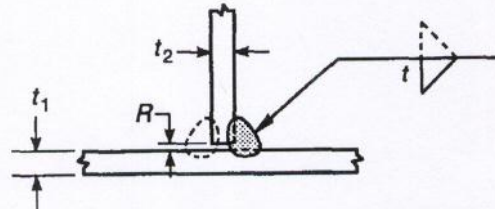

WELDING PROCESSES	THICKNESS, t_1 or t_2 (NOTE 2)	R = ROOT OPENING	POSITIONS
ALL	18 Ga. (MIN)	0 (MIN)	ALL
	7 Ga. (MAX)	$t_1/2$ (MAX) (SEE NOTE 1)	

Notes:

- t_1 = thinnest member when two different thicknesses are involved.
- For equivalent thicknesses for supporting structural members in sheet metal gage terms, use 3/16 in. for 7 Ga., 1/8 in. for 11 Ga.

Fillet Weld in T Joint

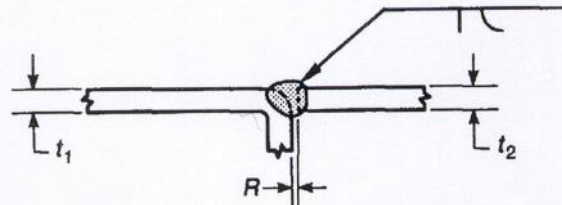

WELDING PROCESSES	THICKNESS (NOTE 2)	R = ROOT OPENING	POSITIONS
ALL	t_1 = 18 Ga. (MIN), 7 Ga. (MAX)	0 (MIN)	ALL
	t_2 = t_1 (MIN), 7 Ga. (MAX)	$t_1/2$ (MAX) (SEE NOTE 1)	

Notes:

- t_1 = thinnest member when two different thicknesses are involved.
- For equivalent thicknesses for supporting structural members in sheet metal gage terms, use 3/16 in. for 7 Ga., 1/8 in. for 11 Ga.

Flare Bevel Groove Weld in Butt Joint

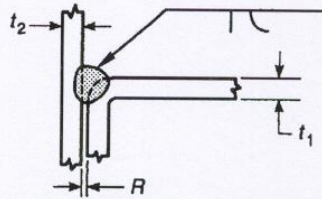

WELDING PROCESSES	THICKNESS (NOTE 2)	R = ROOT OPENING	POSITIONS
ALL	$t_1 = 18 \text{ Ga. (MIN), 7 Ga. (MAX)}$	0 (MIN)	ALL
	$t_2 = t_1 \text{ (MIN), 7 Ga. (MAX)}$	$t_1/2 \text{ (MAX)}$ (SEE NOTE 1)	

Notes:

- t_1 = thinnest member when two different thicknesses are involved.
- For equivalent thicknesses for supporting structural members in sheet metal gage terms, use 3/16 in. for 7 Ga., 1/8 in. for 11 Ga.

Flare Bevel Groove Weld in Corner Joint

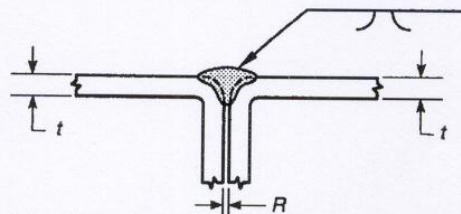

WELDING PROCESSES	THICKNESS, t (NOTE 1)	R = ROOT OPENING	POSITIONS
ALL	7 Ga. (MAX)	0 (MIN)	ALL
	18 Ga. (MIN)	$t/2 \text{ (MAX)}$	

Note:

- For equivalent thicknesses for supporting structural members in sheet metal gage terms, use 3/16 in. for 7 Ga., 1/8 in. for 11 Ga.

Flare V Groove Weld in Butt Joint

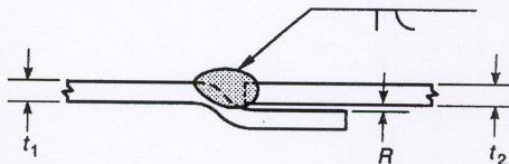

WELDING PROCESSES	THICKNESS (NOTE 2)	R = ROOT OPENING	POSITIONS
ALL	$t_1 = 18 \text{ Ga. (MIN), 7 Ga. (MAX)}$	0 (MIN)	ALL
	$t_2 = t_1 \text{ (MIN), 7 Ga. (MAX)}$	$t_1/2 \text{ (MAX)}$ (SEE NOTE 1)	

Note:

- t_1 = thinnest member when two different thicknesses are involved.
- For equivalent thicknesses for supporting structural members in sheet metal gage terms, use 3/16 in. for 7 Ga., 1/8 in. for 11 Ga.

Flare Bevel Groove Weld in Lap Joint